

Air/gas ratio controls GIK

Technical Information · GB
2 Edition 07.12l

- To maintain a constant gas/air mixture
- For continuous and staged burner control
- Design with inlet pressure compensation diaphragm ensures high control accuracy
- Wide control range
- EC type-tested and certified
- Certified by Gosstandart pursuant to GOST-TR



Contents

Air/gas ratio controls GIK.....	1
Contents	2
1 Application	3
1.1 Examples of application	4
2 Certification	5
3 Function.....	6
4 Flow rate.....	7
4.1 Bypass screw flow rate.....	8
5 Selection	9
5.1 Type code	9
6 Project planning information	10
6.1 Installation.....	10
7 Accessories	11
7.1 Conversion kit for zero pressure control.....	11
7.2 Bypass screw GIK 15 – 25, variable	11
7.3 Bypass screw, diameter to order	11
8 Technical data	12
8.1 Dimensions	13
9 Maintenance cycles	14
Feedback.....	15
Contact.....	15

1 Application



GIK..R



GIK..F

Air/gas ratio controls GIK with inlet pressure compensation diaphragm and zero shut-off serve to maintain a constant gas/air ratio and to control the gas pressure

upstream of gas burners in systems without preheated combustion air.

For use in gas control lines in all sectors of the iron, steel, glass and ceramics industries, as well as in commercial heat generation, such as the packaging, paper and foodstuffs industries.

1.1 Examples of application



Metallurgical industry: bogie hearth furnace



Ceramics industry: intermittent shuttle kiln

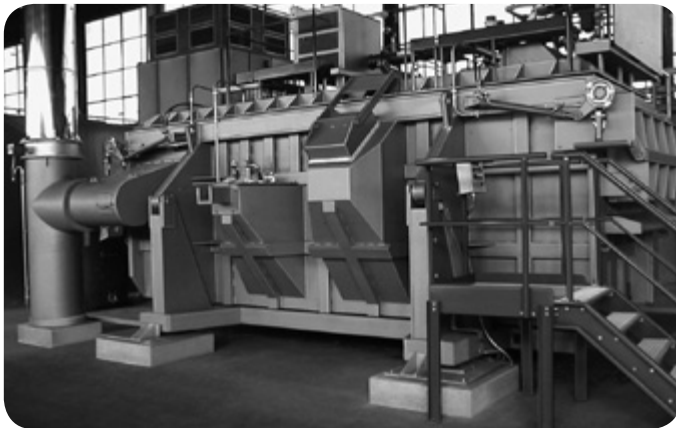

Aluminium industry: smelting furnace

2 Certification

EC type-tested and certified



pursuant to

- Gas Appliances Directive (2009/142/EC) in conjunction with DIN EN 12067-1.

Approval for Russia



Certified by Gosstandart pursuant to GOST-TR.

Approved by Rostekhnadzor (RTN).

Scan of the approval for Russia (RUS) – see www.docuthek.com → Elster Kromschöder → Products → O2 Pressure regulators → Air/gas ratio controls GIK → Kind of document: Certificate → GIK B00093 (nationales Zertifikat Russland) (RUS).

3 Function

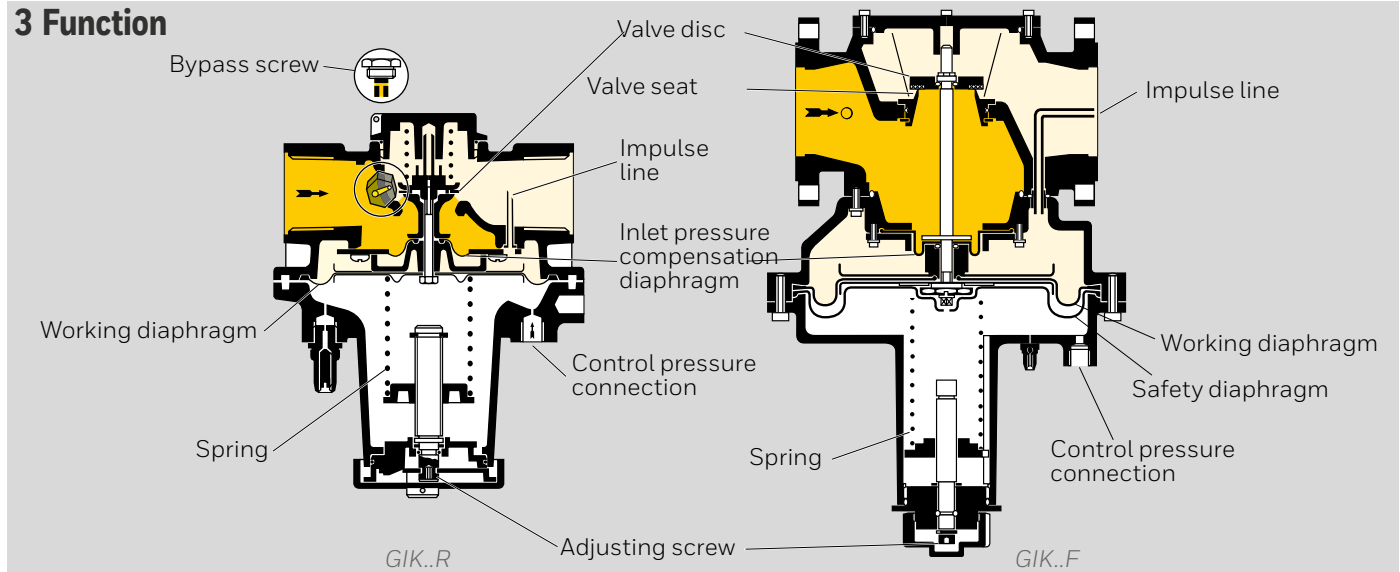

Air/gas ratio control GIK is actuated by the air line pressure. The valve disc is lifted from the valve seat and the gas flows into the regulator outlet area via the open valve seat. The outlet pressure is applied to the space above the working diaphragm via the impulse line. The outlet pressure is controlled in a ratio of 1:1 to the air control pressure. The inlet pressure compensation diaphragm ensures high control accuracy.

The burner capacity can be adjusted using the air control valve. Furnace pressure fluctuations have the same effect on the gas and air throughput so that the gas/air mixture will remain unchanged.

The spring can be used for compensating the weight of the measuring unit. In the low-fire range, the gas/air mixture can be set by adjusting the spring. For staged control, the spring is decompressed at the factory in such a way that the low-fire rate only flows through the bypass.

Adjustment at high-fire rate is carried out using restrictors or valves on the burner.

The zero shut-off prevents an increase in the outlet pressure when the consumer is switched off.

Test nipples have been installed to measure the static inlet, outlet and control pressures.

4 Flow rate

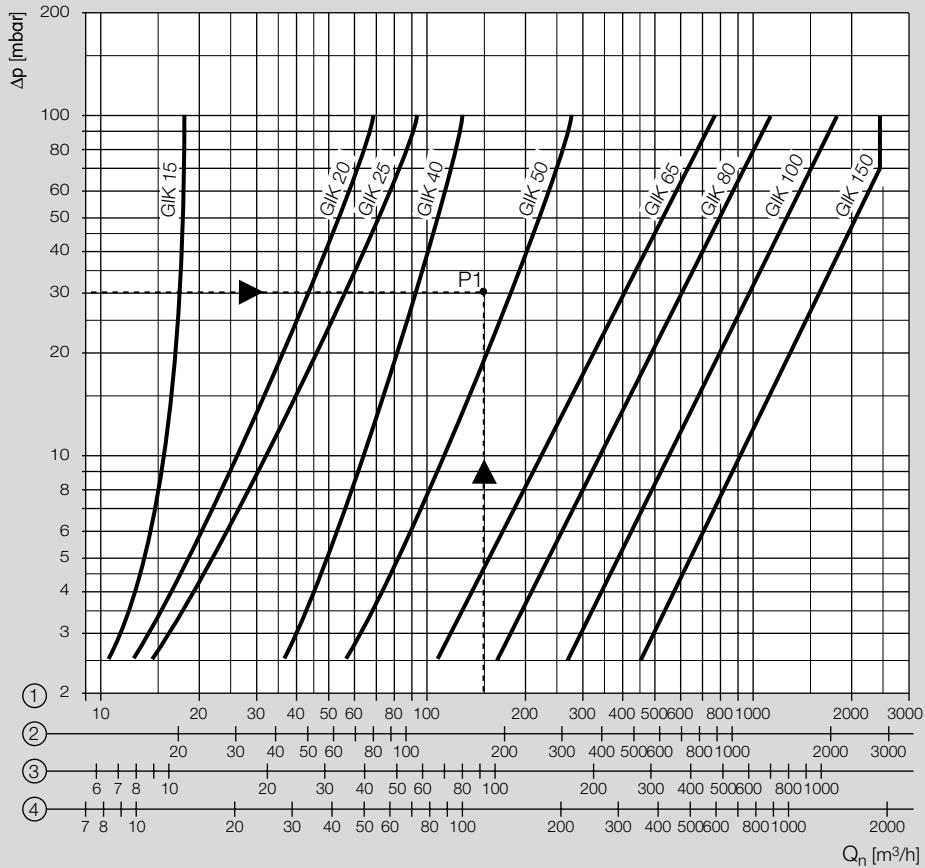

- ① = natural gas ($\rho = 0.80 \text{ kg/m}^3$)
- ② = town gas ($\rho = 0.64 \text{ kg/m}^3$)
- ③ = LPG ($\rho = 2.01 \text{ kg/m}^3$)
- ④ = air ($\rho = 1.29 \text{ kg/m}^3$)

Gas type: natural gas,
 flow rate $Q = 150 \text{ m}^3/\text{h}$,
 inlet pressure $p_u = 50 \text{ mbar}$,
 outlet pressure $p_d = 20 \text{ mbar}$,
 pressure loss $\Delta p = p_u - p_d = 30 \text{ mbar}$.
 The result is intersection P1.
 The next largest nominal size is selected:
 GIK 50.

4.1 Bypass screw flow rate

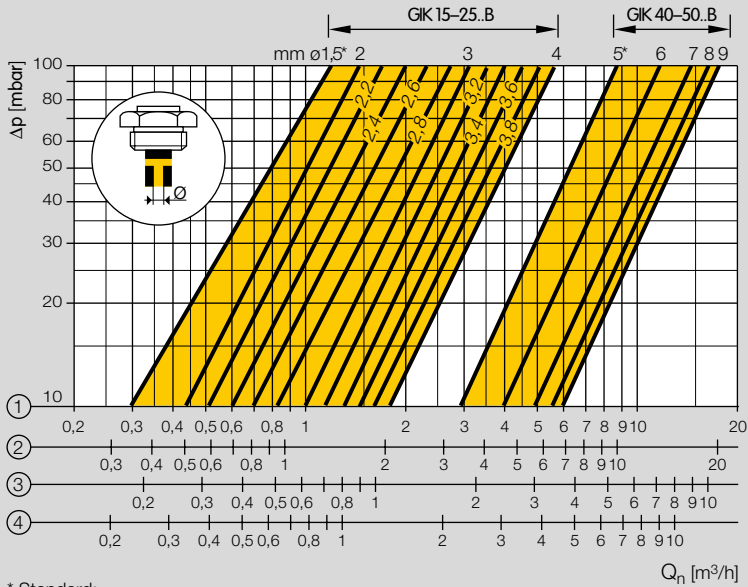

5 Selection

Type	R	F	02	-5	-6	L	B
GIK 15	●	-	●	●	-	○	○
GIK 20	●	-	●	●	-	○	○
GIK 25	●	-	●	●	-	○	○
GIK 40	●	-	●	●	-	○	○
GIK 50	●	-	●	●	-	○	○
GIK 65	-	●	●	-	●	○	-
GIK 80	-	●	●	-	●	○	-
GIK 100	-	●	●	-	●	○	-
GIK 150	-	●	●	-	●	○	-

● = standard, ○ = available

Order example

GIK 40R02-5

5.1 Type code

Code	Description
GIK	Air/gas ratio control
15-150	Nominal size
R	Rp internal thread
F	Flange to ISO 7005
02	p _u max. 200 mbar
-5	Pressure test point at the outlet
-6	Pressure test point at the inlet and outlet
L*	For air only (without approval)
B*	Bypass screw

*If "none", this letter is omitted.

6 Project planning information

The gas inlet pressure p_u must always be greater than the air control pressure p_L + pressure loss Δp to ensure that the air/gas ratio control is not overloaded.

6.1 Installation

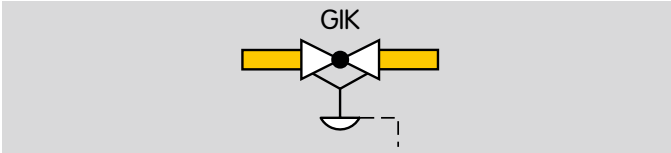

Installation position: spring dome pointing downwards.

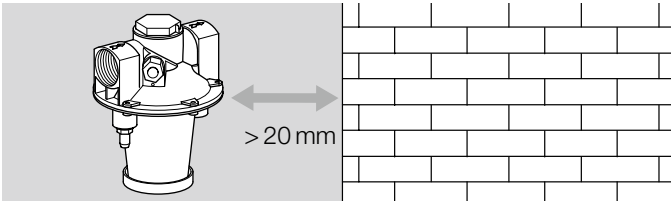

The air/gas ratio control GIK must not be in contact with masonry. Minimum clearance 20 mm.

Do not store or install the unit in the open air.

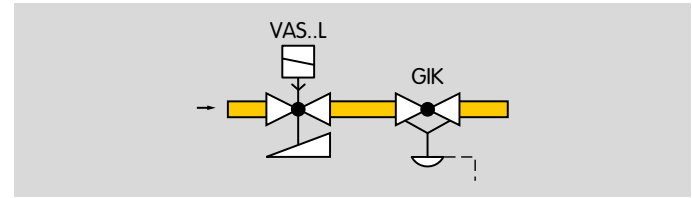

Safety valves must always be installed upstream of the air/gas ratio control GIK. For continuous control, we recommend using slow opening safety valves VAS..L.

7 Accessories

7.1 Conversion kit for zero pressure control

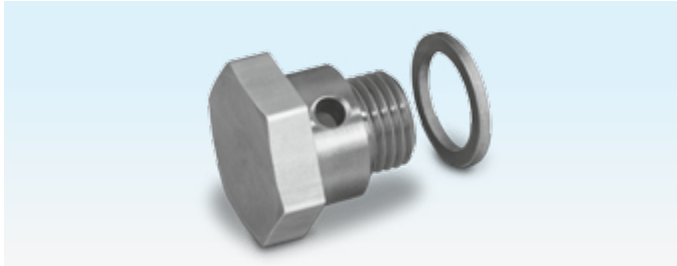

The conversion kit for zero pressure control is screwed in instead of the air impulse line.

Order No.:

GIK 15 – 50: 03351039, GIK 65 – 150: 74910853.

7.2 Bypass screw GIK 15 – 25, variable

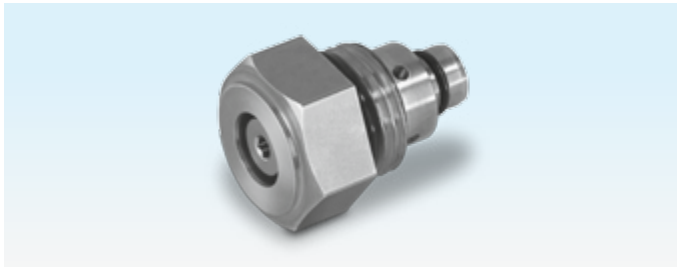

The bore hole diameter for the flow rate can be adjusted as desired and corresponds to holes of 1.5 – 4 mm, see page 8 (Bypass screw flow rate).

Order No.: GIK 15 – 25: 74919806.

7.3 Bypass screw, diameter to order



The bore hole diameter of the bypass screw is made to order.

Order No.:

GIK 15 – 25: 74919820, GIK 40 – 50: 74919821.

8 Technical data

Gas types: natural gas, town gas, LPG (gaseous) and biologically produced methane (max. 0.02 %-by-vol. H₂S), GIK..L also for air. The medium must be dry in all temperature conditions and must not contain condensate.

Air control pressure: 0.5 to 120 mbar.

Outlet pressure: 0.2 to 119 mbar.

Differential pressure between inlet area and outlet pressure: max. 100 mbar.

Transmission ratio: 1:1.

Control range: 1:10.

Internal thread: Rp 1 to ISO 7-1.

Flanged connection: PN 16 to ISO 7005.

Bypass screw: brass.

GIK 15 – 25:

Standard: 1.5 mm, up to 4 mm possible.

GIK 40 – 50:

Standard: 5 mm, up to 9 mm possible.

GIK 15 – 150:

Housing: AlSi.

Diaphragms: NBR.

GIK 15 – 50:

Adjusting range at low fire: -3 to +3 mbar.

Connection for control line: Rp ¼.

Ambient temperature: -20 to +60°C.

Storage temperature: -20 to +40°C.

Valve disc: plastic.

Valve disc seal: NBR.

GIK 65 – 150:

Adjusting range at low fire: -2 to +2 mbar.

Connection for control line: Rp ½.

Ambient temperature: -15 to +60°C.

Storage temperature: -15 to +40°C.

Valve disc: aluminium.

Valve disc seal: vulcanized NBR seal.

8.1 Dimensions

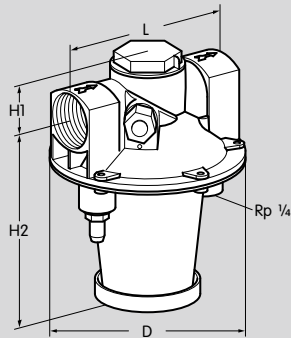

GIK 15-50

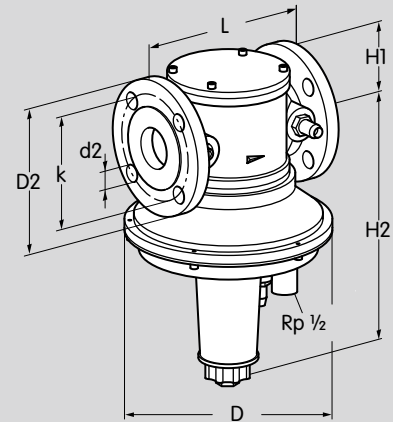

GIK 65-150

Type	Dimensions						p_u max. mbar	Flange		Drilling		Weight kg
	DN	Connection	L mm	H1 mm	H2 mm	D mm		D2	k	d2	No.	
GIK 15	15	Rp 1/2	120	34	132	134	200	-	-	-	-	1.0
GIK 20	20	Rp 3/4	125	34	132	134	200	-	-	-	-	1.1
GIK 25	25	Rp 1	125	34	132	134	200	-	-	-	-	1.1
GIK 40	40	Rp 1 1/2	155	45	149	185	200	-	-	-	-	1.8
GIK 50	50	Rp 2	200	52	167	240	200	-	-	-	-	2.8
GIK 65	65	65	290	89	412	260	200	185	145	18	4	12.0
GIK 80	80	80	310	100	446	310	200	200	160	18	8	16.1
GIK 100	100	100	350	115	501	396	200	229	180	18	8	26.0
GIK 150	150	150	480	150	573	520	200	285	240	22	8	46.5

9 Maintenance cycles

At least once a year, twice a year in the case of biologically produced methane.

Feedback

Finally, we are offering you the opportunity to assess this “Technical Information (TI)” and to give us your opinion, so that we can improve our documents further and suit them to your needs.

Clarity

- Found information quickly
- Searched for a long time
- Didn't find information
- What is missing?
- No answer

Comprehension

- Coherent
- Too complicated
- No answer

Scope

- Too little
- Sufficient
- Too wide
- No answer



Use

- To get to know the product
- To choose a product
- Planning
- To look for information

Navigation

- I can find my way around
- I got “lost”
- No answer

My scope of functions

- Technical department
- Sales
- No answer

Remarks

Contact

Elster GmbH
Postfach 2809 · 49018 Osnabrück
Strothweg 1 · 49504 Lotte (Büren)
Germany

Tel +49 541 1214-0
Fax +49 541 1214-370
info@kromschroeder.com
www.kromschroeder.com

The current addresses of our international agents are available on the Internet:
www.kromschroeder.de/Weltweit.20.0.html?&L=1

We reserve the right to make technical modifications in the interests of progress.
Copyright © 2012 Elster GmbH
All rights reserved.

